

DIMENSION TABLE		MGT-_____
L= _____	RT= _____	
W= _____	BT= _____	
H= _____		

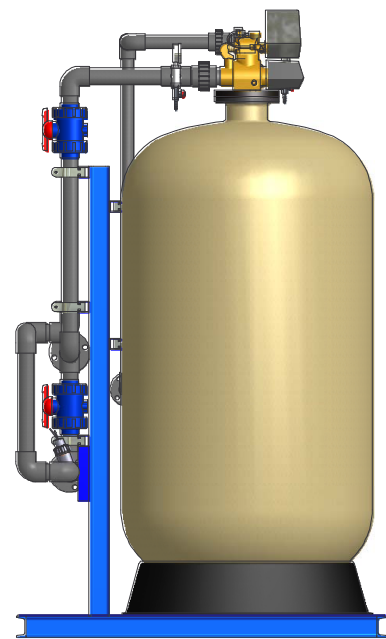

BRINE TANK
BT DIAMETER

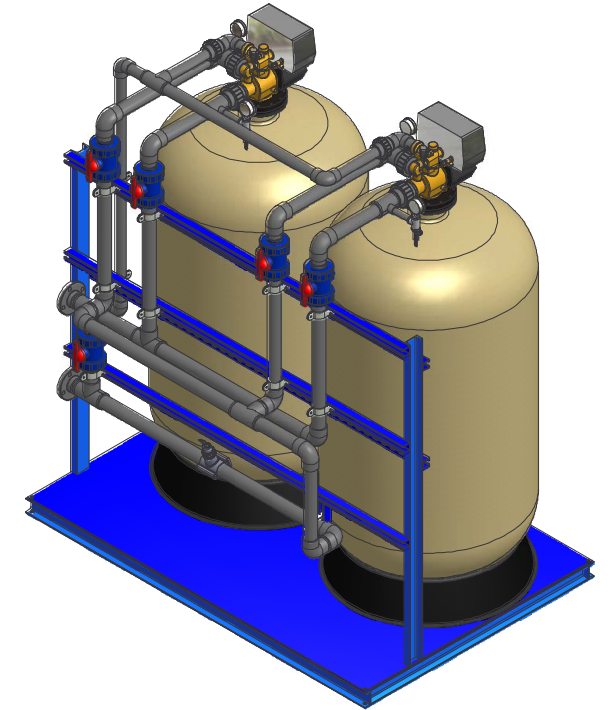
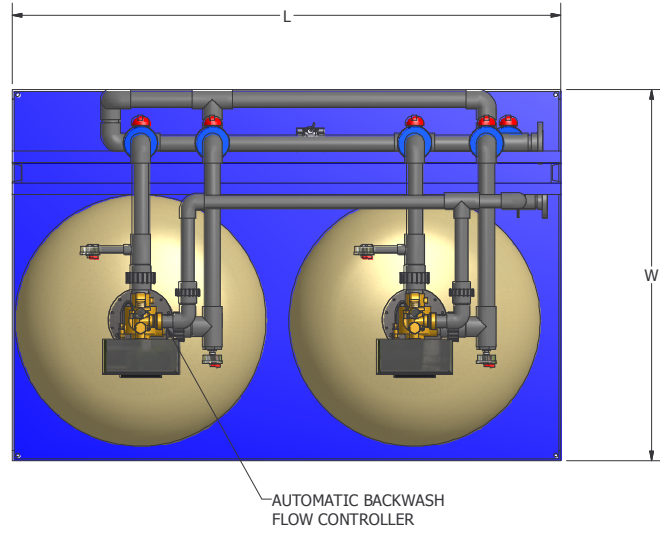
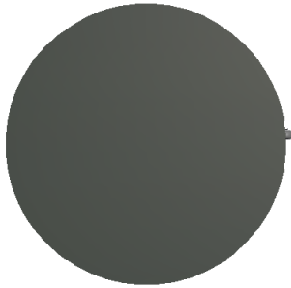
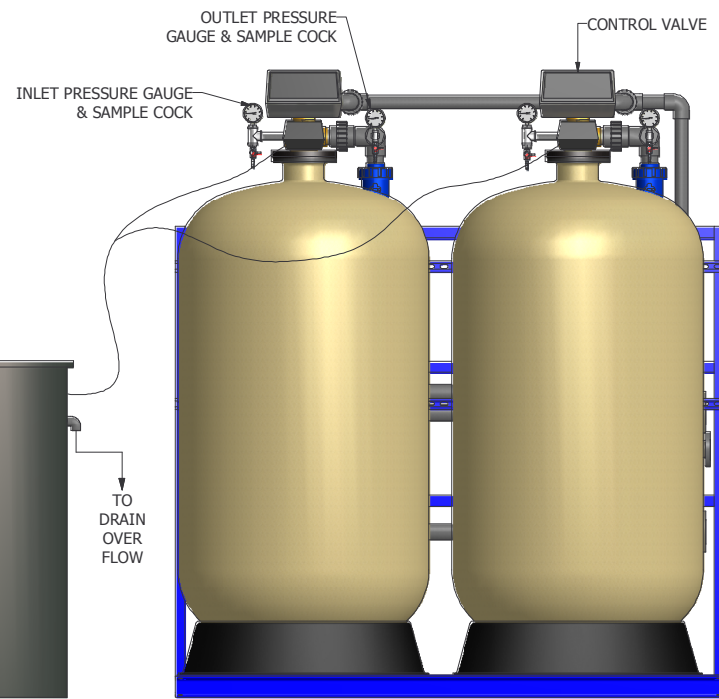

RESIN TANK
RT DIAMETER

RESIN TANK
RT DIAMETER

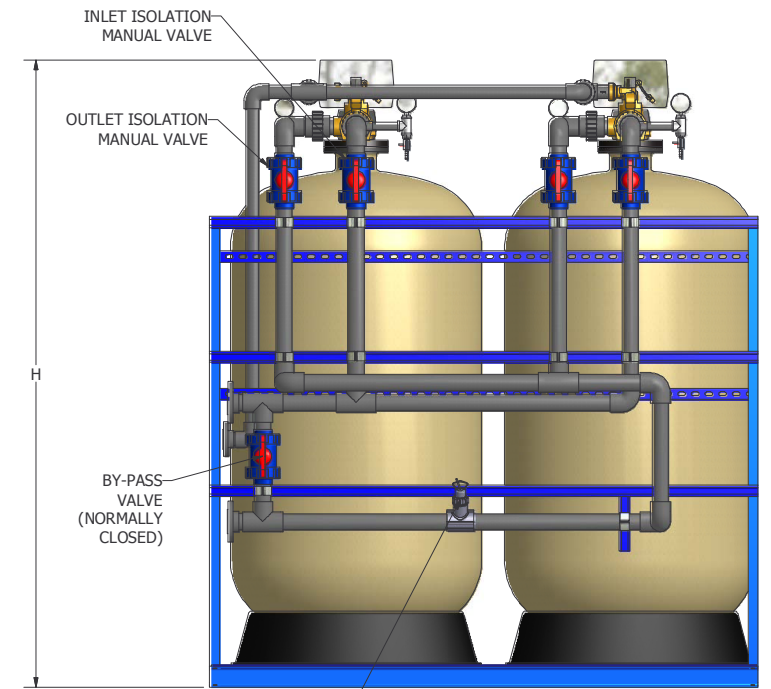
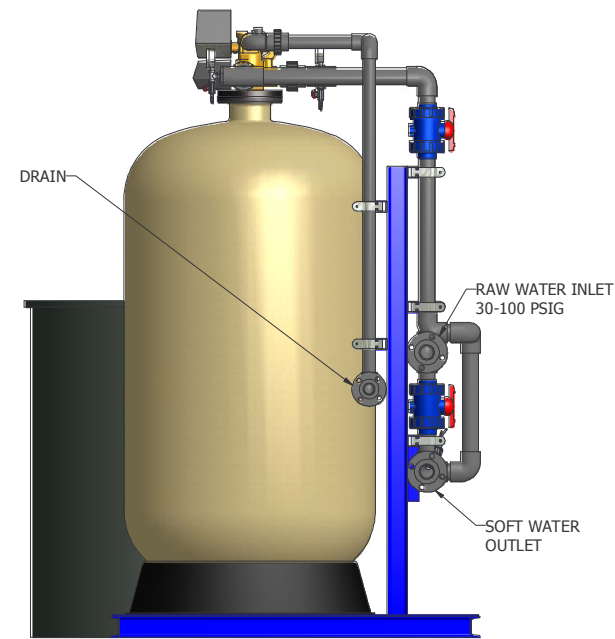

REVISIONS			
NO.	DATE	BY	REMARKS



MGT TWIN ALTERNATING WATER SOFTENER SKID MOUNTED SYSTEM			
FRAC. *	DEC. *	FILE ID.	
DRN. *	AJJG	SCALE	SHEET 1 OF 1
APPD.		DRAWING NO.	MGT TWIN ALT SKID
DATE	4/21/2009	REV.	△